

VISTA

12304TT

LARGE WALL MOUNT LANTERN

Vista creates a strong visual statement with an elongated contemporary silhouette. Constructed with extruded and die-cast aluminum, an angled cut-out creates a modern focal point with a resilient acrylic lens for maximum durability. Vista is offered as an energy-saving LED design in either Bronze or Titanium finish options. Incredibly versatile, the wet-rated Vista can be mounted vertically or horizontally, inside or outdoors.

DETAILS	
FINISH:	Titanium
MATERIAL:	Aluminum
GLASS:	Acrylic Lens
DIMMABLE:	YES - CL TYPE DIMMER (SSL7A)

DIMENSIONS	
WIDTH:	5"
HEIGHT:	29.5"
WEIGHT:	3.5lb
BACK PLATE:	5"W X 6"H
EXTENSION:	3"
TOP TO OUTLET:	14.75"

LIGHT SOURCE	
LIGHT SOURCE:	Integrated LED
LED NAME:	(2) LMP-S100-2
VOLTAGE:	120v
COLOR TEMP:	3000
LUMENS:	2400
CRI:	96
INCANDESCENT EQUIVALENCY:	4 x 60w
DIMMABLE:	YES - CL TYPE DIMMER (SSL7A)

SHIPPING	
CARTON LENGTH:	7
CARTON WIDTH:	5
CARTON HEIGHT:	32
CARTON WEIGHT:	4.5

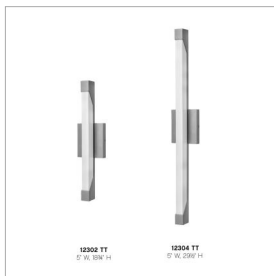
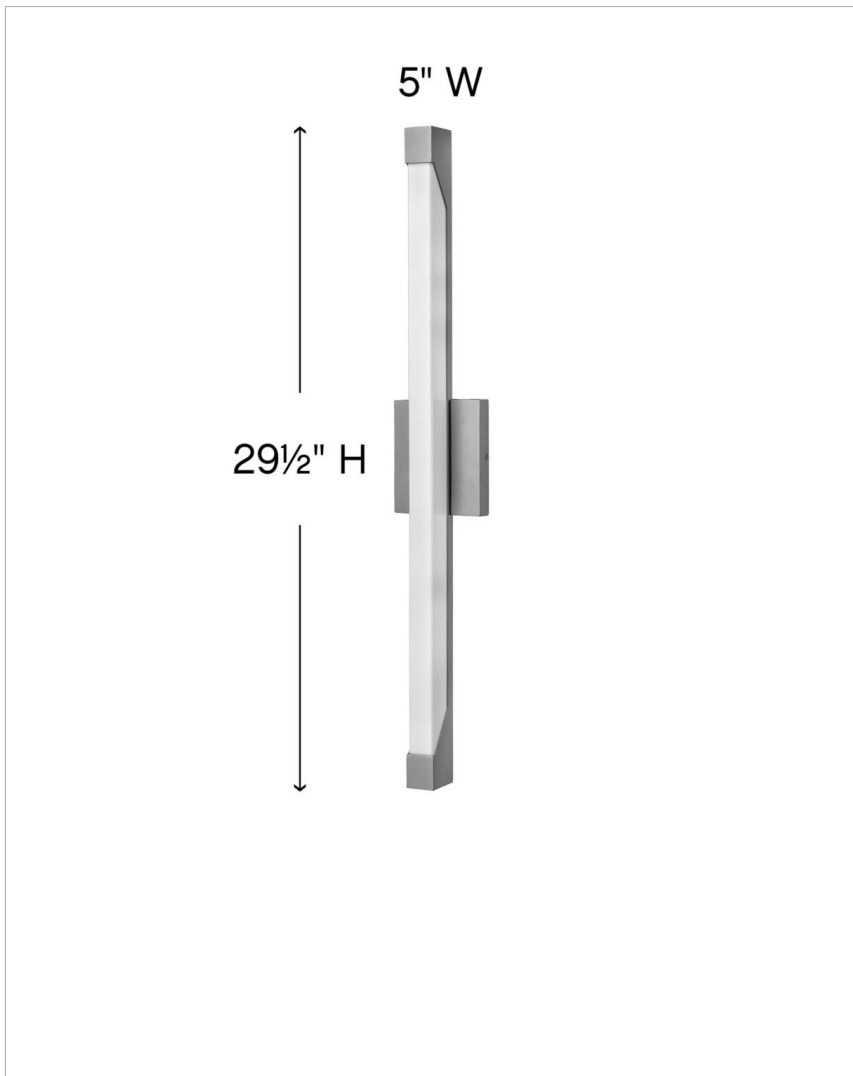

PRODUCT DETAILS:

- Mounting hardware is hidden on the back plate to ensure a clean silhouette
- Fixture can be mounted horizontally.
- Suitable for use in wet (outdoor direct rain) locations as defined by NEC and CEC. Meets United States UL Underwriters Laboratories & CSA Canadian Standards Association Product Safety Standards
- ADA compliant
- Exclusively available in High Performance LED
- 2-year finish warranty
- LED components carry a 5-year limited warranty
- Bold lines and a clean, minimalist style complement contemporary architecture

HINKLEY

HINKLEY
33000 Pin Oak Parkway
Avon Lake, OH 44012

PHONE: (440) 653-5500
Toll Free: 1 (800) 446-5539

hinkley.com